

## Pilot Operated Check Modular Valves

### Specifications

Model Numbers		Max. Operating Pressure MPa (PSI)	Max. Flow L/min (U.S.GPM)
Standard	MP*-03-*-20	25 (3630)	70 (18.5)
Low Pilot Pressure Control Type	MP*-03-*-2001		

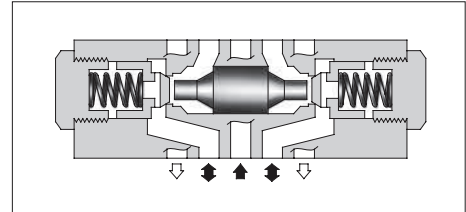

### Model Number Designation

F-	MPA	-03	-2	-20	*
Special Seals	Series Number	Valve Size	Cracking Pressure MPa (PSI)	Design Number	Design Standard
<b>F:</b> Special Seals for Phosphate Ester Type Fluids (Omit if not required)	<b>MPA</b> : Pilot Operated Check Valve for A-Line <b>MPB</b> : Pilot Operated Check Valve for B-Line <b>MPW</b> : Pilot Operated Check Valve for A&B-Lines	<b>03</b>	<b>2</b> : 0.2 (29) <b>4</b> : 0.4 (58)	<b>20</b> (Standard) <b>2001</b> (Low Pilot Pressure Control Type)	Refer to ★

★ Design Standards: None ..... Japanese Standard "JIS", European Design Standard and N. American Design Standard

Model No.	Graphic Symbols	Detailed Graphic Symbols
MPA-03		
MPB-03		
MPW-03		

## Typical Performance Characteristics

Hydraulic Fluid: Viscosity 35 mm<sup>2</sup>/s (164 SSU), Specific Gravity 0.850

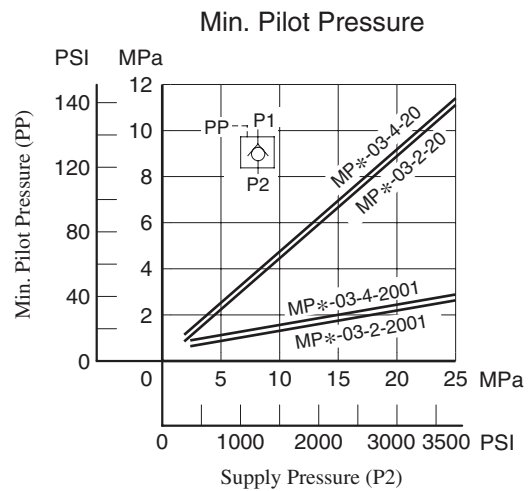
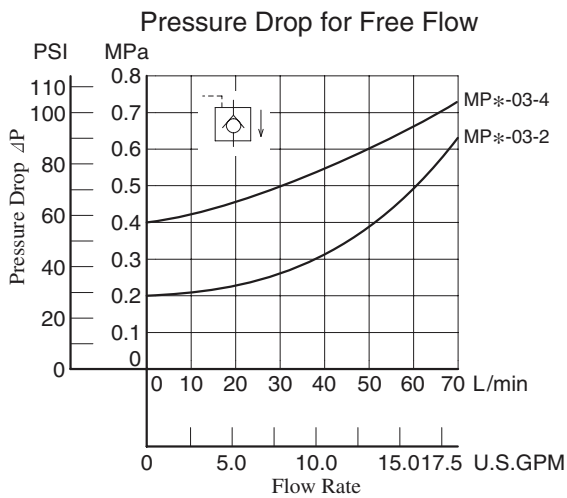
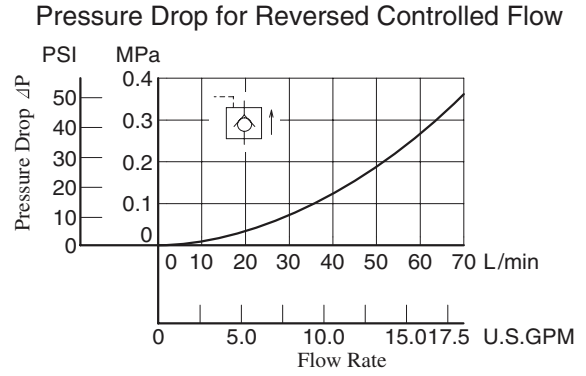
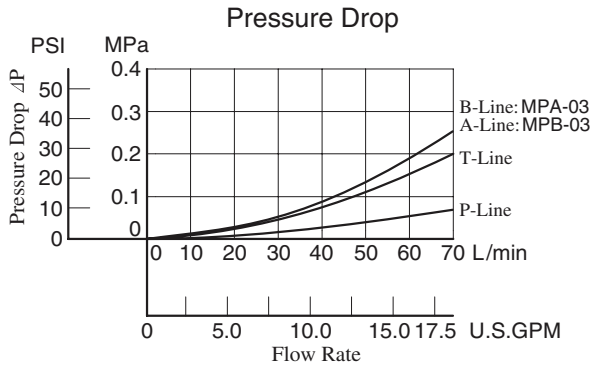

MPA-03-\*-20/2001  
 MPB-03-\*-20/2001  
 MPW-03-\*-20/2001

**DIMENSIONS IN  
 MILLIMETRES (INCHES)**

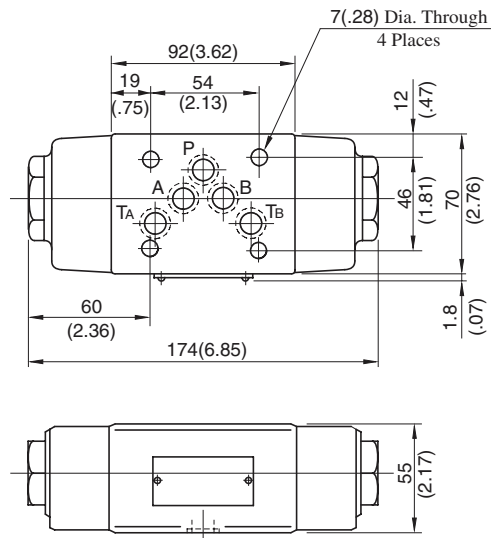

Approx. Mass..... 3.5 kg (7.7 lbs.)

**■ Spare Parts List**

MPA-03-\*-20

MPB-03-\*-20

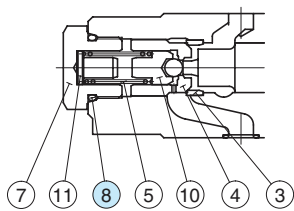
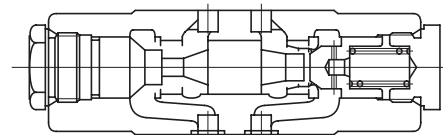
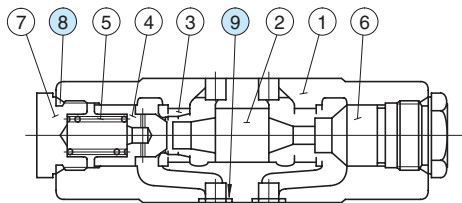

Low Pilot Pressure Control Type  
 (MPA-03-\*-2001)

**● List of Seals**

Item	Name of Parts	Part Numbers	Qty.	Remarks
8	O-Ring	SO-NB-P24	2	Included in Seal Kit
9	O-Ring	SO-NB-A014	5	Kit No.: KS-MPA-03-20

MPW-03-\*-20

